

“SMART ECO 43”

Electronic control for towel radiators

'SMART 43' is an electronic control for towel radiators.

There are ten different types of available resistances: from 100W to 1000W.

Operational modes:

Continuous-Heating, Stand-by, Boost, Timer12, Timer24.

- **“Continuous-Heating”**: the electronic control activates the heating element and remains active until the user decides to set the device in “Stand-by” mode. The maximum temperature of work is 43°C
- **“Boost” mode**: the thermostat feeds the heating element at the maximal power for two hours. At the end of the two hours, the control goes back into the “Stand-by” mode. The temperature of work is 43°C
- **“Timer12” and “Timer 24” mode**: the electronic control activates the “Boost” function for two hours. At the end of the two hours the control enters into “Stand-by” mode for either 10 or 22 hours (the user has the possibility to preset it), after which the thermostat repeats the function “Boost” for two hours. This sequence is repeated cyclically.
- **“Stand-by” mode**: by activating this function, the device goes in stand-by, the heating element is deactivated.



Available colours: - White
- Chromed

SMART 43 is a certified product:



SMART 43 complies to the following directives:

-Eco-design Directive for Energy-using Products, 2005/32/EC (<0,5W).

-EN 60335-1:2012+A11:2014

-EN 60335-2-43:2003+A1:2006+A2:2008

-EN 61000-3-2:2014 -EN61000-3-3:2013 -EN 62233:2008

-EN 55014-1:2006+A1:2009+A2:2011 -EN 55014-2:1997+A1:2001+A2:2008

“SMART ECO 43”

Electronic control for towel radiators

TECHNICAL CHARACTERISTICS

Product	Electronic control for towel radiators
Application	Towel radiators
Insulation class	Class I and Class II
IP level	IP44
Operational temperature	-10°C ÷ 40°C
Maximal power	See table below
Supply Voltage	230VAC 50Hz
Dimensions	See figure below
Warranty	2 years
Standard	-EN 60335-1:2012+A11:2014 -EN 60335-2-43:2003+A1:2006+A2:2008 -EN 61000-3-2:2014 -EN61000-3-3:2013 -EN 62233:2008 -EN 55014-1:2006+A1:2009+A2:2011 -EN 55014-2:1997+A1:2001+A2:2008
Approval Mark	CE
Case	ABS-VO
Environmental directive	WEEE, RoHS
Operative modes	Continuous-heating, Boost2h, Timer12h, Timer24h,Stand-by
Thermostat status indicators	Boost/Timer led (red, green, amber) On/off led (red)
Connection to mains	3 Cables (neutral, earth, live) L.120cm; Italian plug L.120cm; Swiss plug L.120cm; UK plug L.120cm; Schuko plug L.120cm. 2 Cables (neutral, live) Class 2
Available colours	White (RAL 9016); Chromed.
Maximum temperature	43°C

Power	(W)	100	200	250	300	400	500	600	700	750	800	900	1000
L(heating element) class II	(mm)	350	350	350	350	370	410	465	520	560	600	670	730
L(heating element) class I	(mm)	350	350	370	370	430	450	560	630	700	700	760	830

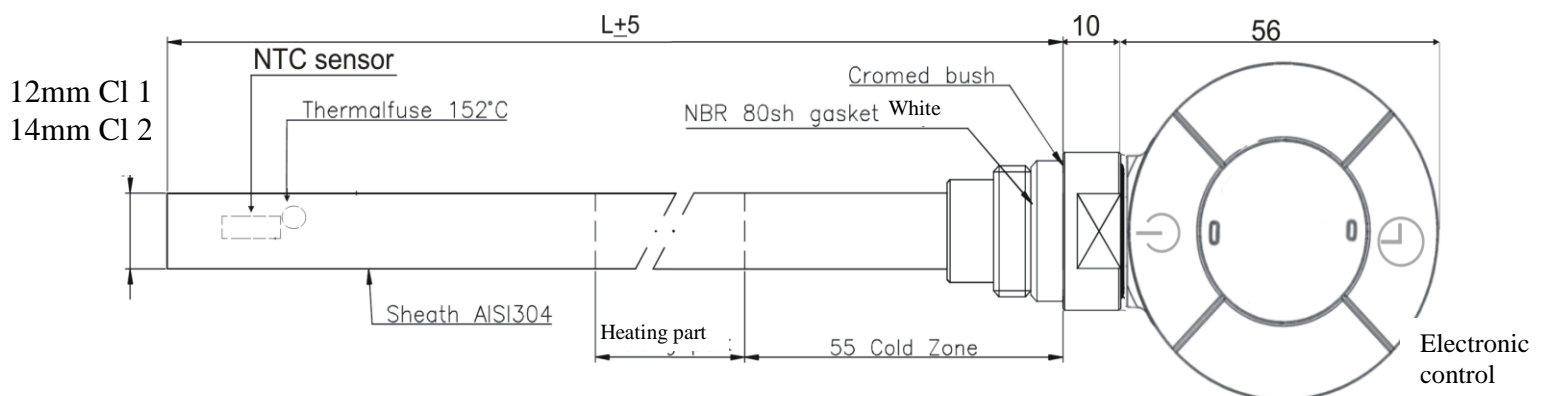

Rev 1. June 2017

“SMART ECO 43”

Electronic control for towel radiators

Warning
Risk of electric shock
Disconnect the power supply before proceeding with the installation

Preserve with care the present instruction sheet and read carefully before using the device.

- The present device has been designed for exclusive use on a towel radiator.
- The thermostat is designed for heating the liquid contained inside a towel radiator in combination with a heating element. Any other use is forbidden.
- Before using, carefully ensure that the line voltage is the same as that specified for the thermostat (see technical specifications).
- Only use heating elements compatible with the type of used towel radiator
- Disconnect the power supply before cleaning or before performing
- In case of damage of the power supply cable shut down the device and do not tamper with it. The damaged power supply cables can be replaced exclusively by the manufacturer or by an authorized service center. Failure to comply with the above rules could lead to compromised system safety and void the warranty.
- Store and transport the heating element exclusively in the protecting packaging.
- Replacement of the heating element can be done exclusively by the product manufacturer.
- Children aged under 8 years old and people with reduced physical, sensory or mental abilities, can use the device only under supervision. Children should not play with the device.
- Cleaning and maintenance meant to be carried out by the user should not be done by children without supervision.

“SMART ECO 43”

Electronic control for towel radiators

Installation Guide

To be used by the installer only

- Disconnect the device from power supply before proceeding with installation or maintenance.
- Protect the device with a 30mA RCD circuit breaker

- 1) Insert the heating element in the threaded opening located on the bottom part of the radiator.
- 2) Securely fasten the electric resistance to the body of the towel radiator with a 22mm wrench.
- 3) The special sheath ensures a secure mounting and eventually allows a slight supplemental torsion to perfectly align the thermostat with the radiator.
- 4) Tilt the radiator as in fig. 3, making sure that the opening on top of the radiator is located on the highest side. **WARNING.** Do not lean the radiator on the electronic control!
- 5) Fill the radiator with the specific liquid.
- 6) Put the radiator back in vertical position and check the internal level of the liquid (fig. 4).
- 7) Ensure a proper fastening of the heating element in the radiator.
- 8) Connect the device to mains and start heating (the top opening of the radiator must remain open!).
- 9) Set the maximal temperature and check the level of the internal liquid.
 - Due to thermal expansion the liquid could brim over the radiator.
 - Remove the exceeding liquid (be careful to avoid burns!) in order to keep the thermostat dry and avoid the liquid reaching the border.

- 10) When the level of the liquid stops growing wait for additional 5 minutes then stop heating.
- 11) If necessary, top up the radiator before the liquid cools down (keep the temperature of the internal liquid checked all the time)
- 12) Close the top opening of the radiator with the appropriate cap.
- 13) Hook the radiator to the wall.
- 14) Connect the device to the mains. For models having no plug it is necessary to install a suitable omnipolar disconnection switch ensuring complete disconnection in case of category III overvoltage (that means a switch with at least 3 mm of space between open contacts).

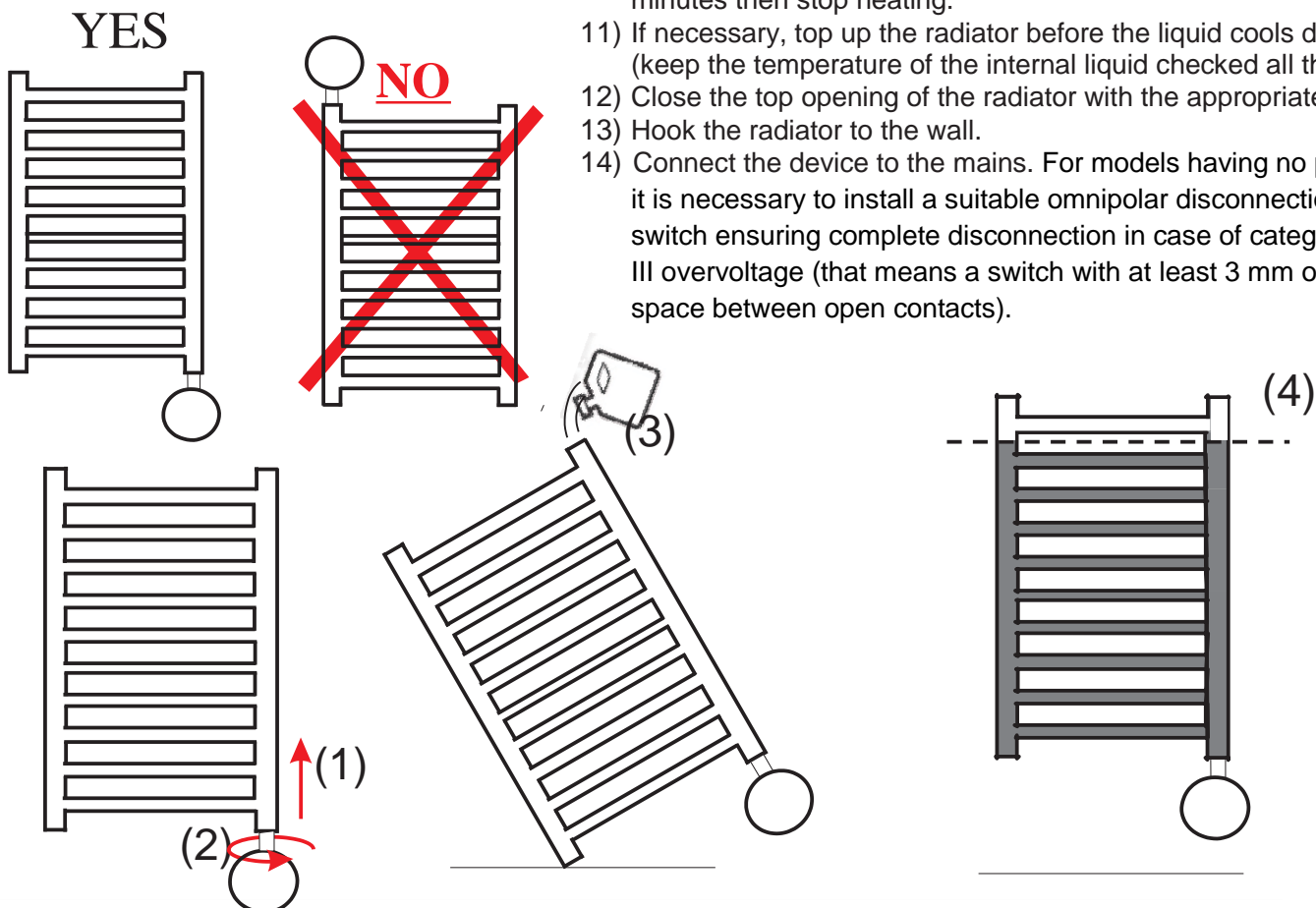

“SMART ECO 43”

Electronic control for towel radiators

User Manual

"On/Stand-by"

led: the led indicates the thermostat status

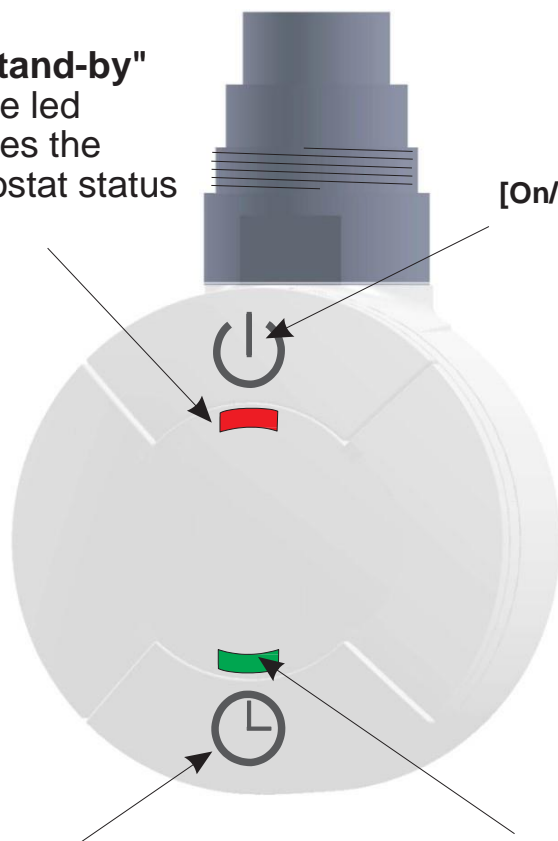

[Bost/Timer] button: to choose among the modes: "Boost", "Timer12", "Timer24"

Led "Boost/Timer": red / green / amber.
A led indicates to the user which functions are active

Heating element

1/2" GAS thread for fastening on the radiator



Press the [On/Stand-by] button to power on the device or to activate the "Stand-by" mode; during the "Stand-by" mode, all led are off.

NOTE:

- When the device enters the "Stand-by" mode, it beeps twice for 0,5 seconds.
- When the device is switched to "On" mode (i.e. it is switched on), it beeps once for 1sec.

"Continuous-heating" mode: it is possible to activate this function through the [ON/Stand-by] button, the heating element is activated and remains active (hence heating the towel radiator) until the function is deactivated through the [ON/Stand-by] button. From this mode it is possible to activate the functions: "Boost", "Timer12" e "Timer24".

Note: the maximal reachable temperature depends on the power of resistance (see technical specifications).

Note: the maximum temperature is 43°C.

“SMART ECO 43”

Electronic control for towel radiators

“Boost” mode: Press the **[Boost/Timer]** button to activate this operative mode. This mode activates the heating element to the maximum power for 2hrs. To exit the “Boost” mode press the **[Boost/timer]** button.





  “Boost” mode indication: “Boost/Timer” LED has red color and it blinks.

“Timer24” mode: Press the **[Boost/Timer]** button for 3 seconds to activate this mode.

The control system activates the “Boost” mode for 2 hours, after that it returns into “Stand-by” mode and after 22 hours the “Boost” mode is started again for 2 hours. This sequence will repeat endlessly.

To exit the “Timer24” mode press the **[Boost/Timer]** button.





NOTE: During the first cycle the duration of the “Stand-by” mode is of 21 hours.

  “Timer24” indication during 2hrs “Boost”: “Boost/Timer” LED blinking green.
  During 22hrs “Stand-by”: “Boost/Timer” LED permanent green.

“Timer12” mode: Press the **[Boost/Timer]** button for more than 5 seconds to activate it. The control system activates the “Boost” mode for 2 hours, after that it returns into “Stand-by” mode and after 10 hours the “Boost” mode is started again for 2 hours. This sequence will repeat endlessly.

To exit the “Timer12” mode press the **[Boost/Timer]** button.

NOTE: During the first cycle the duration of the “Stand-by” mode is of 9 hours.

  Timer12 mode (boost 2h): Boost/Timer led amber and blinking
  “Stand-by” mode (12h): Boost/Timer lit and amber

Note: the maximum temperature is 43°C

Functional diagram

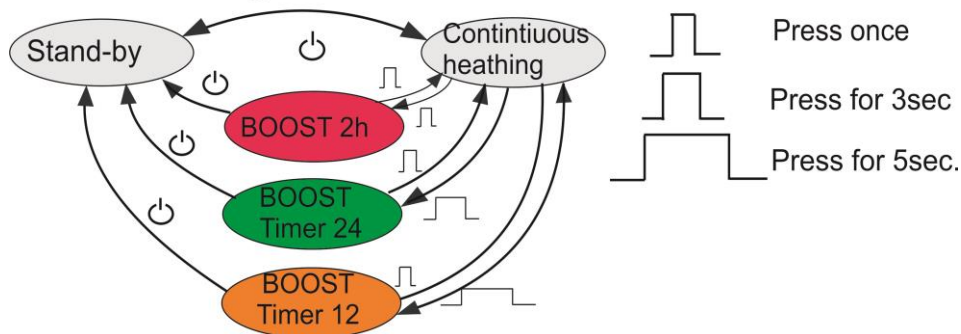

“SMARTECO 43”

Electronic control for towel radiators

Functional diagram of the "On/Stand-by" led

Led off	Stand-by mode
Red lit led	The thermostats is active

Functional diagram of the "Boost/Timer" led

Blinking red	Boost active. The heating element is active for 120 minutes.
Blinking green	Boost active (Timer24). The heating element is active for 120 minutes.
Green	Return to "Stand-by" mode for 22 hours.
Blinking amber	Boost active (Timer12). The heating element is active for 120 minutes.
amber	Return to "Stand-by" mode for 10 hours.

NOTE:- In case of interruption of the power supply the thermostat remains in "Continuous -heating" mode, with the exception of the modes: "Boost2h", "Timer12h", "Timer24h", from which the thermostat goes back into "Stand-By"

- "On/Stand-by" led red blink: Failure on the temperature sensor, the heating element is deactivated. Contact customer support.

Accessory: For the mixed operation with the Smart control, mount the “T” accessory in the way back of the towel radiator, and subsequently introduce into the vertical manifold of the “T” accessory the smart, and connect the way back of the heating circuit to the square connection of the “T” accessory.



Available colours: White; Chromed

Repairing: they must be carried out by authorized personnel in order not to void the warranty. The manufacturer reserves the right to make any changes to the product described in this manual, at any time, and without prior warning.

DISPOSAL

This product may not be treated as ordinary household waste. It has to be disposed in proper waste collection sites. In case of replacement it shall be returned to the distributor.



Such an end-of-life treatment of the product will preserve the environment and will reduce consumption of natural resources.

This symbol applied to the present product indicates the obligation to bring it to a proper waste collection site, in order to let it be disposed according to 2002/96 / CE (RAEE - WEEE) directives.

Rev 1. June 2017